

GHBH Series

GHBH 1D7 34 1R4

Technical datasheet



Goorui blower performance curves

Vacuum selection diagram curve

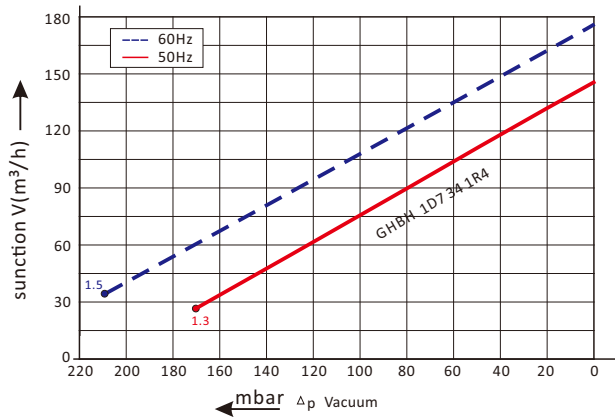

Compressor selection diagram curve

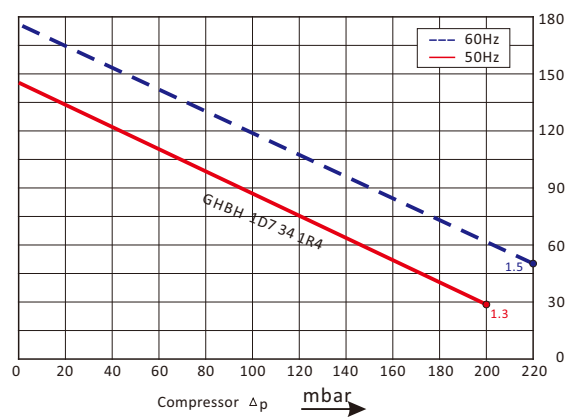

Goorui blower installation drawing

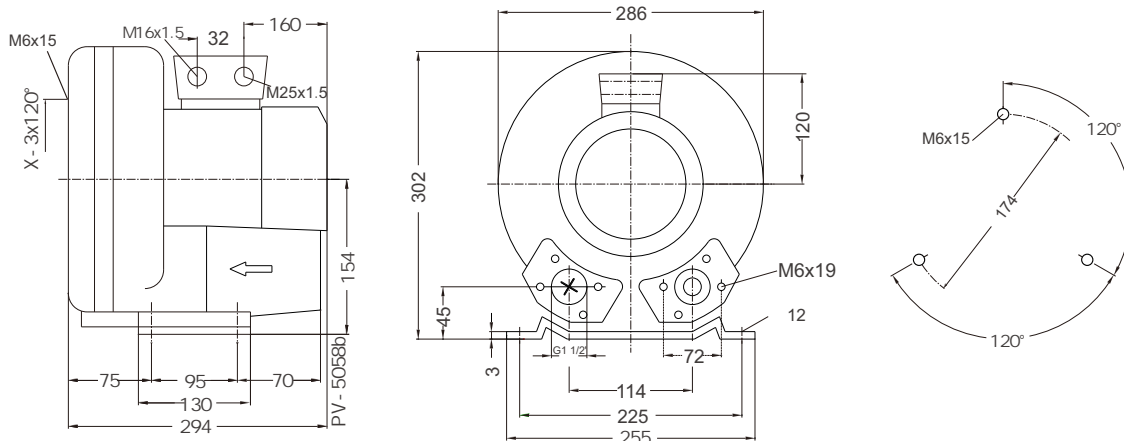

Goorui blower parameter

Model	Frequency	Output	voltage	Current	airflow	pressure		noise	Weight
						vacuum	compressor		
	Hz	KW	V	A	m ³ /h	mbar	mbar	dB(A)	kg
3~ 50/60Hz IP54 INSULATION class F									
GHBH 1D7 34 1R4	50	1.3	200-240 Δ /345-415Y	5.7 Δ /3.3Y	145	-170	200	63	16
GHBH 1D7 34 1R4	60	1.5	220-275 Δ /380-480Y	5.7 Δ /3.3Y	175	-210	220	64	16

The performance curves of Goorui blower is tested through below ways:

Under one atmospheric pressure, suck 15°C air and then you can calculate the data, of course allow 10% difference, and when the sucked air and surroundings temperature are not higher than 25°C, you still can get total pressure difference as the curves shows.