

"L" Style Compact Vacuum Filters CSL Series 3/8" - 3"

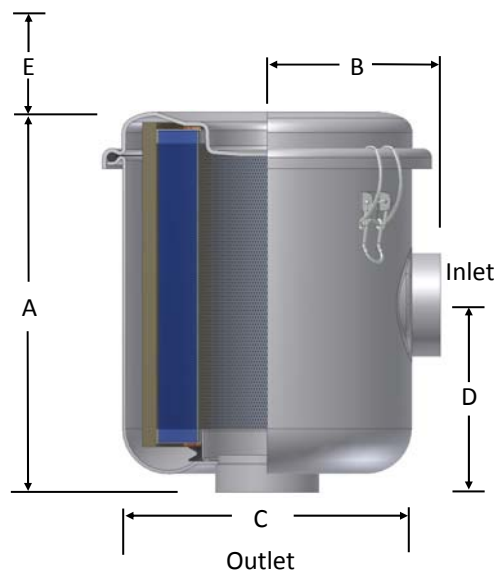

Features

- Seamless drawn housings
- O-ring seal
- Corrosion resistant carbon steel construction
- Powder coat finish
- Stainless steel torsion clips for durability

Technical Specifications

- Vacuum Rating: Medium vacuum service**
- Temp (continuous): min -26°C (-15°F) max 104°C (220°F)
- Filter change out differential: 37-50 mbar over initial ΔP
- Polyester: 99%+ removal efficiency standard to 5 micron
- Paper: 99%+ removal efficiency standard to 2 micron

**See Vacuum Filter Technical Data for Vacuum Service Data.

Benefits

- Large dirt holding capacity and easy field cleaning, especially when mounted horizontally or inverted
- Low pressure design

Options



- Vacuum gauge
- Higher holding capacity configurations available (select models)
- Material/Finishes: stainless steel, epoxy coating
- Support brackets
- Alternative top-to-canister fastening system for low pressure or pulsating systems
- Stainless steel (select models)

Inlet/ Outlet Size	Inlet/ Outlet Type	Assembly m ³ / h Rating	Housing Config.	Assembly Part Number		Dimensions - mm				Suggested Service HT. E	Approx. Weight kg	Replacement Element Part No.		Element m ³ / h Rating
				Polyester	Paper	A	B	C	D			Polyester	Paper	
3/8"	BSPP	31	A	CSL-825-039HCB	CSL-824-039HCB	85	54	95	46	76	0.40	825	824	43
1/2"	NPSC	31	A	CSL-825-050HCB	CSL-824-050HCB	89	57	95	49	76	0.40	825	824	43
1/2"	NPSC	34	B	CSL-843-050HCB	CSL-842-050HCB	103	76	146	64	83	1.4	843	842	94
3/4"	NPSC	41	A	CSL-825-075HCB	CSL-824-075HCB	89	58	95	50	76	0.40	825	824	43
3/4"	NPSC	43	B	CSL-843-075HCB	CSL-842-075HCB	103	76	146	64	83	1.4	843	842	94
1"	BSPP	60	B	CSL-843-101HCB	CSL-842-101HCB	111	83	146	67	83	1.4	843	842	94
1"	BSPP	68	C	CSL-849-101HCB	CSL-848-101HCB	170	105	187	114	133	2.3	849	848	196
1 1/4"	BSPP	94	B	CSL-843-126HCB	CSL-842-126HCB	111	83	146	67	83	1.4	843	842	94
1 1/4"	BSPP	102	C	CSL-849-126HCB	CSL-848-126HCB	170	105	187	114	133	2.3	849	848	196
1 1/2"	BSPP	136	C	CSL-849-151HCB	CSL-848-151HCB	171	105	187	114	133	2.3	849	848	196
2"	BSPP	298	D	CSL-851-201HCB	CSL-850-201HCB	260	114	222	127	235	6.8	851	850	493
2 1/2"	BSPP	357	D	CSL-851-251HCB	CSL-850-251HCB	271	130	222	140	235	6.8	851	850	493
3"	BSPP	510	E	CSL-239-301HCB	CSL-238-301HCB	362	184	337	182	279	15	239	238	969

See Vacuum Filter Technical Data section for sizing guidelines.

Note: NPSC threaded housings are interchangeable with BSPP up to 1".

Note: Model offerings & design parameters may change without notice. Contact Solberg for CAD drawings or see www.solbergmfg.com.